

# SPECIFICATION OF BSF□□□NRSTY SERIES

## FEATURES

1. Low profile and miniature size construction .
2. Magnetic shielded construction.
3. High saturation current.
4. For D/D converter units of new generation portable products.

## APPLICATIONS

DVD、DSC、PDA、LCD display、  
Smart phones、HDD、etc.

## ORDERING CODE

**BSF5012NRSTY 1R0 N T**  
(1)                      (2) (3) (4)

- (1) Code of PRODUCT TYPE AND SIZE  
(2) INDUCTANCE  
(3) INDUCTANCE TOLERANCE ( M : ±20%, N : ±30% )  
(4) REEL TAPING

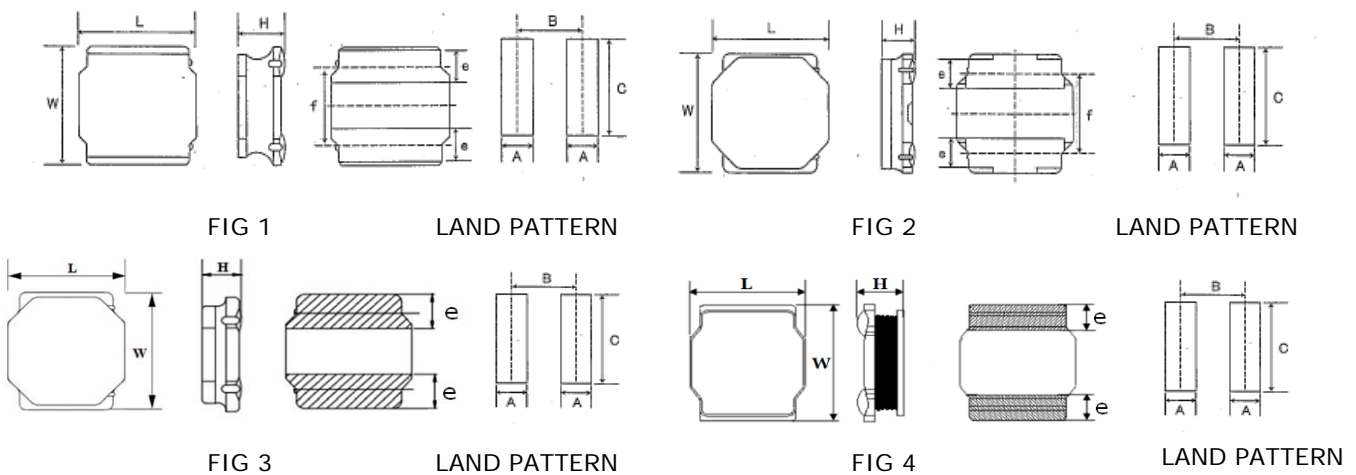
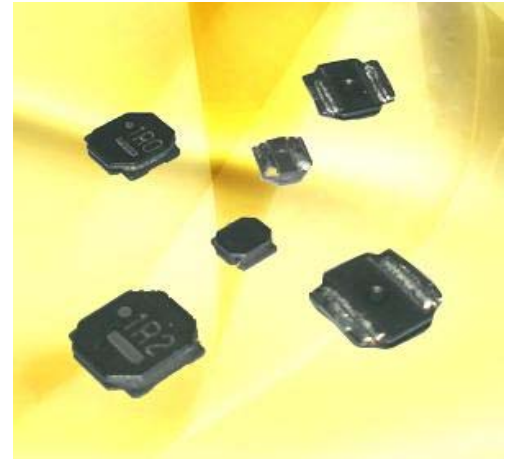

## SHAPE & DIMENSIONS

SIZE CODE	L	W	H (max)	e	f	A	B	C	FIG
BSF3015NRSTY	3.0±0.1	3.0±0.1	1.5	0.9±0.2	1.9±0.2	0.8	2.2	2.7	1
BSF4010NRSTY	4.0±0.2	4.0±0.2	1.0	1.1±0.2	2.5±0.2	1.2	2.8	3.7	1
BSF4012NRSTY	4.0±0.2	4.0±0.2	1.2	1.1±0.2	2.5±0.2	1.2	2.8	3.7	1
BSF4018NRSTY	4.0±0.2	4.0±0.2	1.8	1.2REF	-	1.2	2.8	3.7	3
BSF5010NRSTY	4.9±0.2	4.9±0.2	1.0	1.2±0.2	3.3±0.2	1.5	3.6	4.0	2
BSF5012NRSTY	4.9±0.2	4.9±0.2	1.2	1.2±0.2	3.3±0.2	1.5	3.6	4.0	2
BSF5020NRSTY	4.9±0.3	4.9±0.3	2.2	1.3REF	-	1.5	3.6	4.0	3
BSF5024NRSTY	4.9±0.2	4.9±0.2	2.5	1.2±0.2	3.3±0.2	1.5	3.6	4.0	2
BSF5040NRSTY	4.9±0.3	4.9±0.3	4.1	1.3REF	-	1.5	3.6	4.0	3

※All the data listed in this catalogue are for reference only, King Core reserves the right to alter or revise the specifications without prior notification.

# SPECIFICATION OF BSF□□□NRSTY SERIES

## FEATURES

1. Low profile and miniature size construction .
2. Magnetic shielded construction.
3. High saturation current.
4. For D/D converter units of new generation portable products.

## APPLICATIONS

DVD · DSC · PDA · LCD display ·  
Smart phones · HDD · etc.

## ORDERING CODE

BSF5012NRSTY 1R0 N T  
(1) (2) (3) (4)

- (1) Code of PRODUCT TYPE AND SIZE  
(2) INDUCTANCE  
(3) INDUCTANCE TOLERANCE ( M : ±20%, N : ±30% )  
(4) REEL TAPING

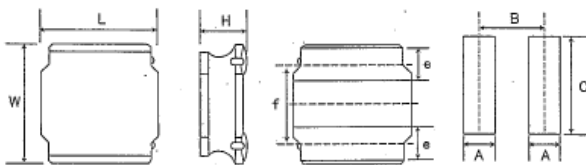
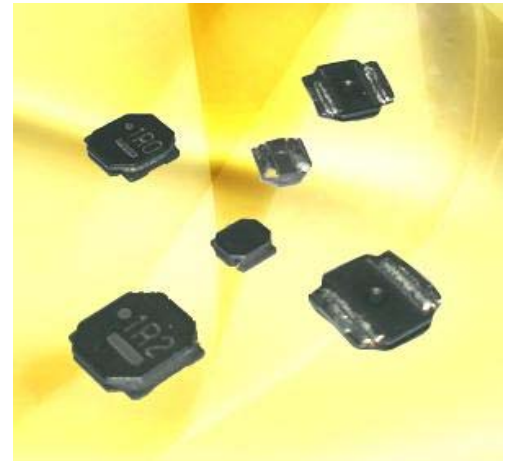

FIG 1

LAND PATTERN

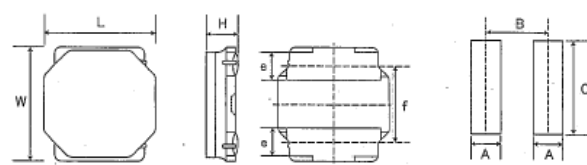

FIG 2

LAND PATTERN

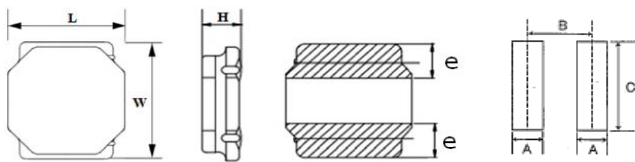

FIG 3

LAND PATTERN

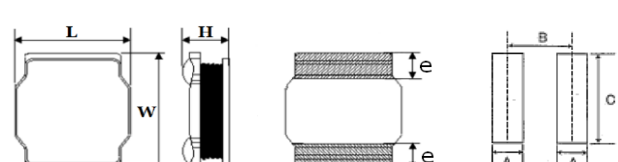

FIG 4

LAND PATTERN

## SHAPE & DIMENSIONS

SIZE CODE	L	W	H (max)	e	f	A	B	C	FIG
BSF6010NRSTY	6.0±0.2	6.0±0.2	1.0	1.35±0.20	4.0±0.2	1.6	4.7	5.7	2
BSF6012NRSTY	6.0±0.2	6.0±0.2	1.2	1.35±0.20	4.0±0.2	1.6	4.7	5.7	2
BSF6014NRSTY	6.0±0.2	6.0±0.2	1.4	1.35±0.20	4.0±0.2	1.6	4.7	5.7	2
BSF6020NRSTY	6.0±0.2	6.0±0.2	2.0	1.35±0.20	4.0±0.2	1.6	4.7	5.7	2
BSF6028NRSTY	6.0±0.2	6.0±0.2	2.8	1.35±0.20	4.0±0.2	1.6	4.7	5.7	2
BSF6045NRSTY	6.0±0.2	6.0±0.2	4.5	1.6REF	-	1.6	4.7	5.7	3
BSF8030NRSTY	8.0±0.2	8.0±0.2	3.0	1.6±0.3	5.6±0.3	1.8	5.6	7.5	1
BSF8040NRSTY	8.0±0.2	8.0±0.2	4.2	2.1REF	-	1.8	5.6	7.5	4

※All the data listed in this catalogue are for reference only, King Core reserves the right to alter or revise the specifications without prior notification.

# SMD POWER INDUCTORS → BSF5012NRSTY SERIES

## ELECTRICAL CHARACTERISTIC

ORDERING CODE	Inductance ( $\mu\text{H}$ )	DC Resistance ( $\Omega$ ) $\pm 20\%$	Self Resonant Frequency (MHz)min	Isat (mA)max	IDC (mA)max
BSF5012NRSTY1R0NT	1.0	0.053	100	4500	2300
BSF5012NRSTY1R5MT	1.5	0.070	86	3800	2200
BSF5012NRSTY2R2MT	2.2	0.085	70	3100	2000
BSF5012NRSTY3R3MT	3.3	0.160	48	2400	1450
BSF5012NRSTY4R7MT	4.7	0.180	40	2200	1400
BSF5012NRSTY6R8MT	6.8	0.260	36	1700	1100
BSF5012NRSTY100MT	10	0.420	26	1400	850
BSF5012NRSTY150MT	15	0.670	22	1200	640

※Test Frequency/Voltage: 100KHz/1V

※Tolerance: M $\pm 20\%$ , N $\pm 30\%$

※Isat: Based on Inductance decrease 30%

※IDC: Based on Temperature increase 40°C

※Operating temperature range : -25 to +125°C (including self-generated heat)

※All the data listed in this catalogue are for reference only, King Core reserves the right to alter or revise the specifications without prior notification.