

SPECIFICATION OF WCM- 453228 SERIES

FEATURES

From big to lowprofile and very small size SMD Design,
Wound Chip constructure with standard 0504, 0603, 0805...
to 1812 size, with best EMI suppression effect
but least impact to data signal wave form.



APPLICATIONS

Preventive measure against high speed signal
radiation emissions such as USB 2.0,
IEEE1394 or LAN interface and Power Line.
Best for NB, DSC, mobile device design.
WCM-453226/28 type is for automobile CAN bus design.

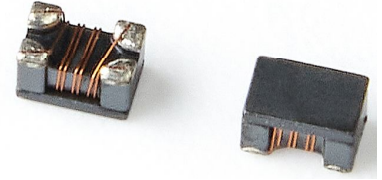

ORDERING CODE

WCM-453228-110Y T 04
(1) (2) (3) (4) (5)

- (1) PRODUCT TYPE CODE
- (2) PRODUCT SIZE CODE
- (3) INDUCTANCE
- (4) TAPING
- (5) REF CODE

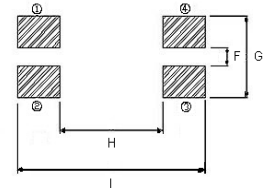
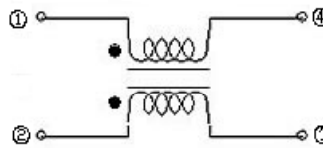
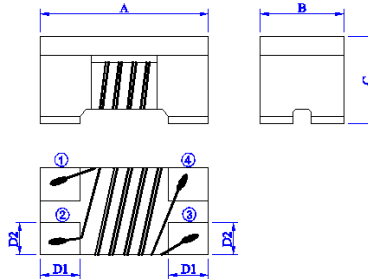

APPEARANCE & DIMENSIONS

UNIT:mm (inch)

SIZE CODE	A	B	C	D1 TYP	D2 TYP	F TYP	G TYP	H TYP	I TYP		
WCM-1210 (0504)	1.20±0.20 (0.047±0.008)	1.00±0.20 (0.039±0.008)	0.90±0.20 (0.035±0.008)	0.36 (0.014)	0.38 (0.015)	0.30 (0.012)	1.20 (0.047)	0.60 (0.024)	1.50 (0.059)		
WCM-2012 (0805)	2.00±0.20 (0.079±0.008)	1.20±0.20 (0.047±0.008)	1.20±0.20 (0.047±0.008)	0.45 (0.018)	0.40 (0.016)	0.40 (0.016)	1.20 (0.047)	0.80 (0.031)	2.60 (0.102)		
WCM-2520 (1008)	2.50±0.20 (0.098±0.008)	2.00±0.20 (0.079±0.008)	1.20±0.20 (0.047±0.008)	0.50 (0.020)	0.70 (0.028)	0.50 (0.020)	2.10 (0.083)	1.50 (0.063)	3.10 (0.146)		
WCM-3216 (1206)	3.20±0.20 (0.126±0.008)	1.60±0.20 (0.063±0.008)	2.00±0.20 (0.079±0.008)	0.60 (0.024)	0.60 (0.024)	0.40 (0.016)	1.60 (0.063)	1.60 (0.063)	3.70 (0.146)		
WCM-3225 (1210)	3.30±0.20 (0.129±0.008)	2.60±0.20 (0.102±0.008)	2.50±0.15 (0.098±0.008)	0.50 (0.020)	0.90 (0.035)	0.60 (0.023)	3.50 (0.137)	1.60 (0.063)	4.00 (0.157)		
WCM-4525 (1810)	4.80±0.20 (0.189±0.008)	2.80±0.20 (0.110±0.008)	2.20+0.35(-0.20) (0.087+0.0137-0.0078)	0.75 (0.030)	0.75 (0.030)	0.70 (0.027)	2.70 (0.106)	3.00 (0.118)	5.50 (0.216)		
WCM-4532 (1812)	4.50±0.20 (0.177±0.008)	3.20±0.20 (0.126±0.008)	2.80+0.35(-0.20) (0.110+0.0137-0.0078)	1.00 (0.039)	1.00 (0.039)	0.40 (0.016)	3.60 (0.141)	2.10 (0.082)	4.90 (0.192)		

※All the data listed in this catalogue are for reference only, King Core reserves the right to alter or revise the specifications without prior notification.

SPECIFICATION OF WCM SERIES

FEATURES

Lowprofile and very small size SMD Design,
Wound Chip constructure with standard 0805
to 1812 size, with best EMI suppression effect
but least impact to data signal wave form.



APPLICATIONS

Preventive measure against high speed signal
radiation emissions such as USB 2.0,
IEEE1394 or LAN interface.
Best for NB, DSC, mobile device design.

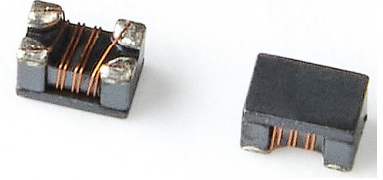

ORDERING CODE

WCM-453228-110Y T 04
(1) (2) (3) (4) (5)

- (1) PRODUCT TYPE CODE
- (2) PRODUCT SIZE CODE
- (3) INDUCTANCE
- (4) TAPING
- (5) REF CODE

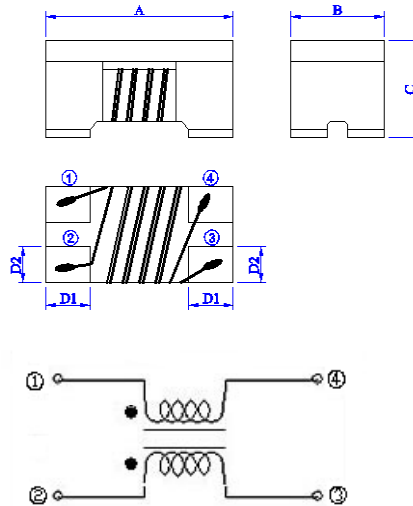

APPEARANCE & DIMENSIONS

UNIT:mm (inch)

SIZE CODE	A	B	C	D1 TYP	D2 TYP	F TYP	G TYP	H TYP	I TYP		
WCM-453226 (1812)	4.50±0.20 (0.177±0.008)	3.20±0.20 (0.126±0.008)	2.60+0.45(-0.20) (0.102+0.0177-0.0078)	1.00 (0.039)	1.00 (0.039)	0.40 (0.016)	3.60 (0.141)	2.10 (0.082)	4.90 (0.192)		
WCM-453228 (1812)	4.50±0.20 (0.177±0.008)	3.20±0.20 (0.126±0.008)	2.80+0.35(-0.20) (0.110+0.0137-0.0078)	1.00 (0.039)	1.00 (0.039)	0.40 (0.016)	3.60 (0.141)	2.10 (0.082)	4.90 (0.192)		

※All the data listed in this catalogue are for reference only, King Core reserves the right to alter or revise the specifications without prior notification.

COMMON MODE CHOKE → WCM-453228 SERIES

ELECTRICAL CHARACTERISTICS

ORDERING CODE	INDUCTANCE (μ H) 100KHz/100mV	IMPEDANCE (Ω)TYP 10MHz	DC Resistance (Ω) max	IDC (mA) max	Rated Voltage V (DC)	Insulation Resistance (m Ω) min
WCM-453228-110YT04	11+50(-30)%	600	0.6	250	50	10
WCM-453228-220YT04	22+50(-30)%	1200	1.0	200	50	10
WCM-453228-510YT04	51+50(-30)%	2800	1.0	200	50	10

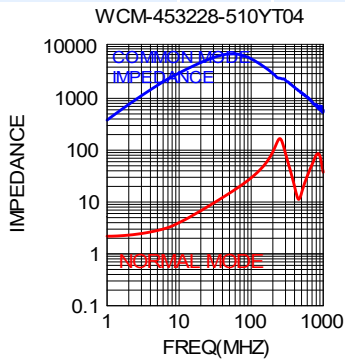
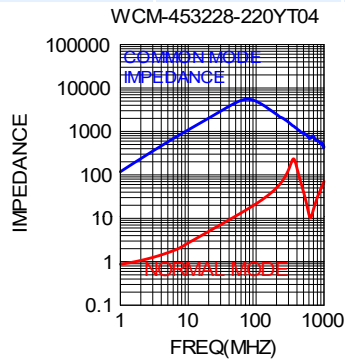
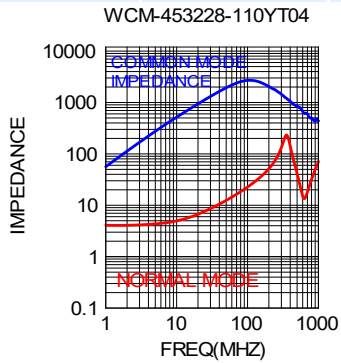

※IDC:Based on Temperature increase 40℃
 ※Operating temperature range : -25 to +85℃ (including self-generated heat)
 *Design as Customer's Requested Specifications.

※All the data listed in this catalogue are for reference only, King Core reserves the right to alter or revise the specifications without prior notification.