

SPECIFICATION OF FT SERIES

APPLICATIONS

The FT cores are used for IC shielding as radiation absorber.



ORDERING CODE

K5B FT 23 x 1.5 x 23 - G□
 (1) (2) (3) (4) (5) (6)



- (1) MATERIAL
- (2) PRODUCT CODE
- (3) A DIM.
- (4) B DIM.
- (5) C DIM.
- (6) DOUBLE SIDED ADHESIVE TAPE



SHAPE

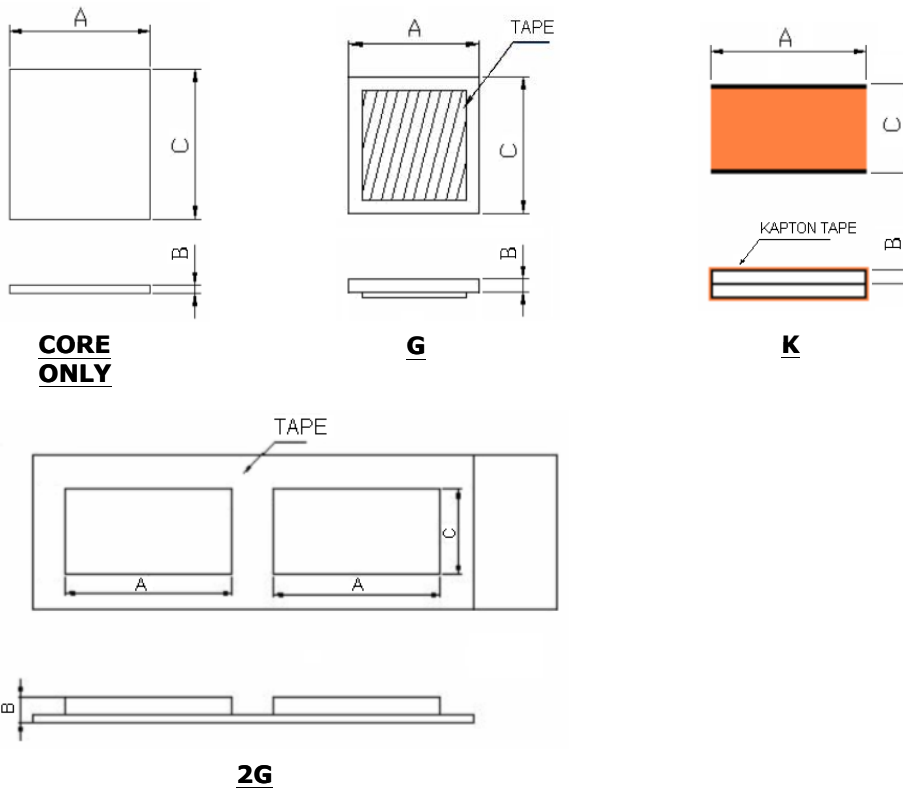

DIMENSIONS & CHARACTERISTICS

UNIT:mm

NO.	ORDERING CODE	A	B	C
1	FT 3x0.8x12	3.00±0.15	0.80±0.20	12.00±0.40
2	FT 10x1.0x5	10.00±0.30	1.00±0.15	5.00±0.20
3	FT 10x1.0x10	10.00±0.30	1.00±0.15	10.00±0.40
4	FT 12x1.0x6	12.00±0.30	1.00±0.15	6.00±0.20
5	FT 16x0.5x5	16.00±0.50	0.50±0.15	5.00±0.20
6	FT 20x0.6x13	20.00±0.60	0.60±0.15	13.00±0.40
7	FT 20x0.6x15	20.00±0.60	0.60±0.15	15.00±0.50
8	FT 20x0.8x15	20.00±0.60	0.80±0.20	15.00±0.50
9	FT 20x1.5x10	20.00±0.60	1.50±0.20	10.00±0.40
10	FT 20x1.5x15	20.00±0.60	1.50±0.20	15.00±0.50

※Other sizes are available upon request.

※All the data listed in this catalogue are for reference only, King Core reserves the right to alter or revise the specifications without prior notification.

SPECIFICATION OF FT SERIES

NO.	ORDERING CODE	A	B	C
11	FT 20x1.5x18	20.00±0.60	1.50±0.20	18.00±0.50
12	FT 20x1.5x20	20.00±0.60	1.50±0.20	20.00±0.60
13	FT 20x1.5x30	20.00±0.60	1.50±0.20	30.00±0.75
14	FT 20x2x20	20.00±0.60	2.00±0.20	20.00±0.60
15	FT 20x2.5x20	20.00±0.60	2.50±0.20	20.00±0.60
16	FT 20.5x1.0x10	20.50±0.60	1.00±0.20	10.00±0.40
17	FT 23x0.5x23	23.00±0.60	0.50±0.15	23.00±0.60
18	FT 23x0.8x23	23.00±0.60	0.80±0.20	23.00±0.60
19	FT 23x1.0x23	23.00±0.60	1.00±0.15	23.00±0.60
20	FT 23x1.5x23	23.00±0.60	1.50±0.20	23.00±0.60
21	FT 23x3x23	23.00±0.60	3.00±0.40	23.00±0.60
22	FT 25x1.0x10	25.00±0.60	1.00±0.15	10.00±0.30
23	FT 27x0.32x20x12	27.00±0.80	0.32±0.10	20.00±0.60/D:12.00±0.40
24	FT 28x0.5x28	28.00±0.80	0.50±0.20	28.00±0.80
25	FT 28x0.8x28	28.00±0.80	0.80±0.20	28.00±0.80
26	FT 28x1.5x28	28.00±0.80	1.50±0.20	28.00±0.80
27	FT 28x2x28	28.00±0.80	2.00±0.20	28.00±0.80
28	FT 30x1.0x30	30.00±0.80	1.00±0.20	30.00±0.60
29	FT 30x1.0x36	30.00±0.80	1.00±0.20	36.00±0.75
30	FT 30x1.5x30	30.00±0.80	1.50±0.20	30.00±0.75
31	FT 30x3x15	30.00±0.80	3.00±0.40	15.00±0.50
32	FT 32x1.0x4	32.00±0.80	1.00±0.15	4.00±0.20
33	FT 40x1.5x18	40.00±1.00	1.50±0.20	18.00±0.50
34	FT 42x0.32x27	42.00±1.00	0.32±0.10	27.00±0.80
35	FT 50x1.5x18	50.00±1.00	1.50±0.20	18.00±0.50
36	FT 70x3x50	70.00±1.30	3.00±0.40	50.00±1.00
37	FT 100x5.5x100	100.00±0.20	5.50±0.10	100.00±0.20
38	FT 100x6x100	100.00±0.20	6.00±0.10	100.00±0.20
39	FT 100x6.7x100	100.00±0.20	6.70±0.10	100.00±0.20

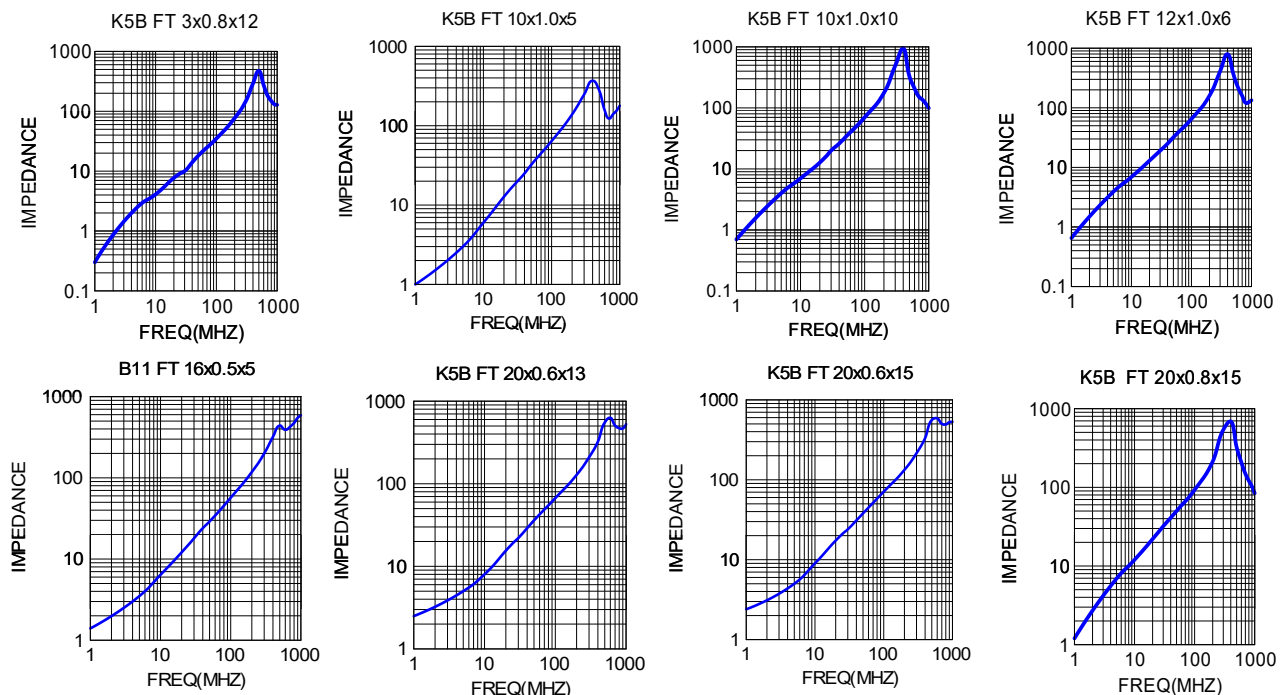

※Other sizes are available upon request.

※All the data listed in this catalogue are for reference only, King Core reserves the right to alter or revise the specifications without prior notification.

SPECIFICATION OF FT SERIES

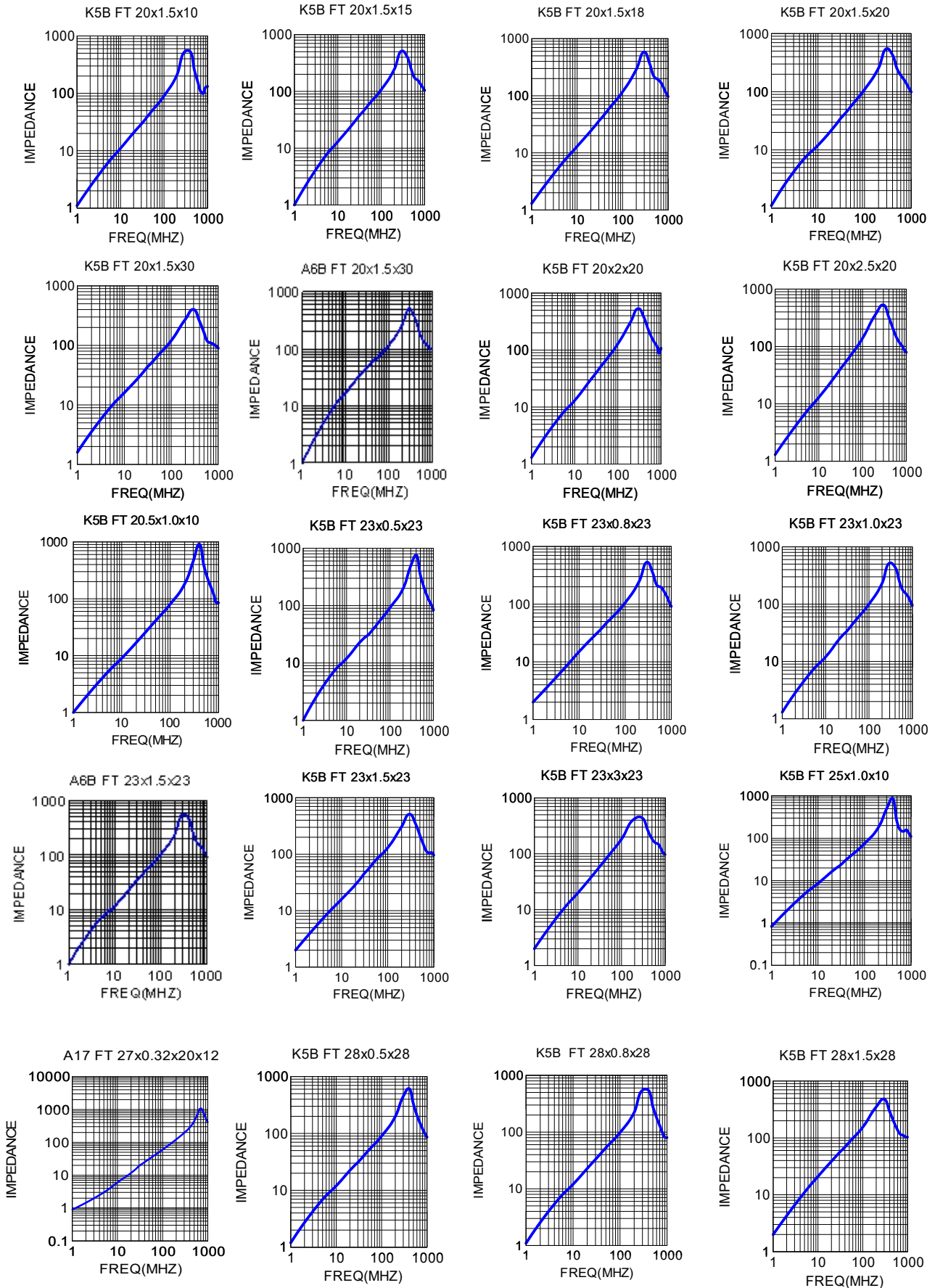

※Other sizes are available upon request.

※All the data listed in this catalogue are for reference only, King Core reserves the right to alter or revise the specifications without prior notification.

SPECIFICATION OF FT SERIES

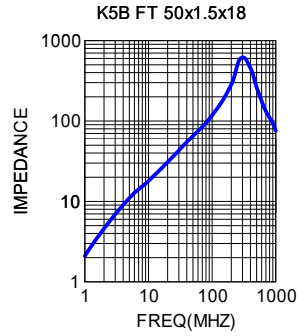
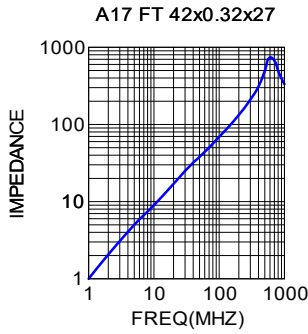
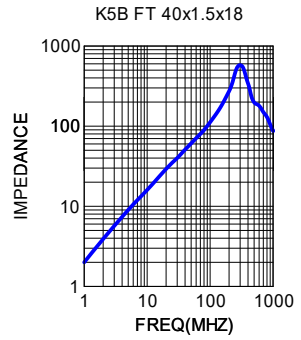
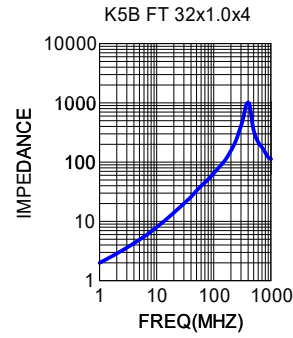
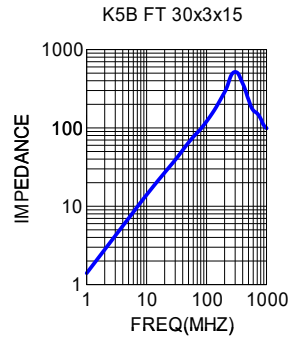
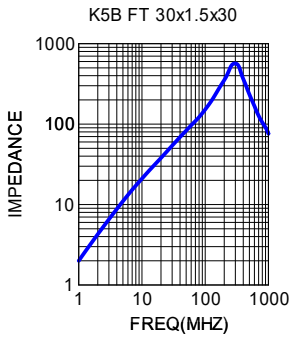
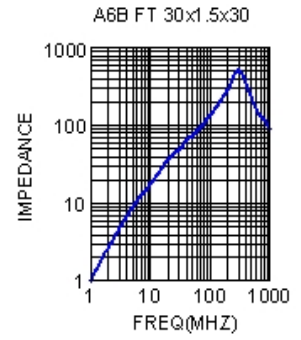
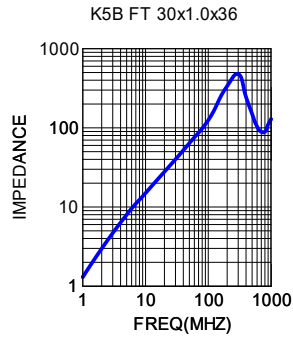
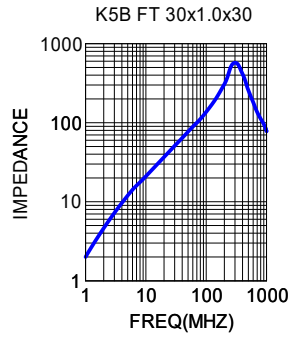
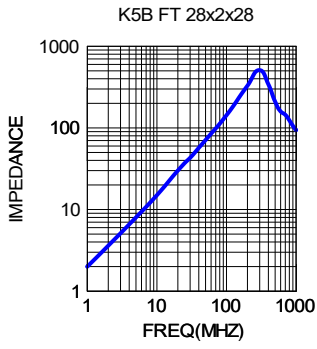

※Other sizes are available upon request.

※All the data listed in this catalogue are for reference only, King Core reserves the right to alter or revise the specifications without prior notification.

