

SPECIFICATION OF FS SERIES

APPLICATIONS

The rectangular solid ferrites are used for EMI suppression on flat cable assemblies.

- * Internal floppy disk ribbon cables.
- * Internal ribbon cables between circuit and data connectors.
- * Internal ribbon cables with 8,16,32 or 64 bit digital signal busses.



ORDERING CODE

K5B FS 45.2 x 6.5 x 12 - 1.3 - G□
 (1) (2) (3) (4) (5) (6) (7)

- (1) MATERIAL
- (2) PRODUCT CODE
- (3) A DIM.
- (4) B DIM.
- (5) C DIM.
- (6) E DIM.
- (7) DOUBLE SIDED ADHESIVE TAPE



SHAPE

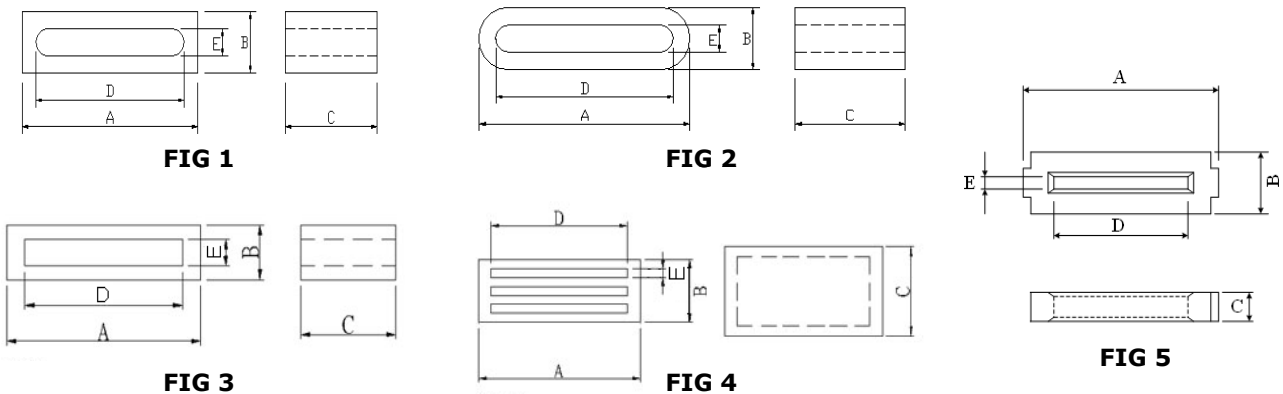

DIMENSIONS & CHARACTERISTICS

UNIT:mm

NO.	ORDERING CODE	A	B	C	D	E	Fig
1	FS 5x3x9-1.0	5.00±0.20	3.00±0.20	9.00±0.40	3.00±0.20	1.00±0.20	3
2	FS 5.5x3x9-1.4	5.50±0.20	3.00±0.20	9.00±0.30	4.00±0.20	1.40±0.20	3
3	FS 6.5x3.8x9-1.4	6.50±0.20	3.80±0.20	9.00±0.30	4.00±0.20	1.40±0.20	3
4	FS 7.5x5.3x9-2.8	7.50±0.30	5.30±0.20	9.00±0.30	5.00±0.25	2.80±0.20	3
5	FS 7.5x5.3x12-2.8	7.50±0.30	5.30±0.20	12.00±0.50	5.00±0.25	2.80±0.20	3
6	FS 9.1x5.6x7.8-3.7	9.10±0.20	5.60±0.20	7.80±0.30	7.20±0.20	3.70±0.20	3
7	FS 9.5x3x12-0.8	9.50±0.30	3.00±0.20	12.00±0.50	7.60±0.20	0.80±0.20	3
8	FS 10x3.2x3-1.0	10.00±0.30	3.20±0.20	3.00±0.50	8.00±0.30	1.00±0.20	3
9	FS 10x3.2x7-1.0	10.00±0.30	3.20±0.20	7.00±0.30	8.00±0.30	1.00±0.20	3
10	FS 10x3.2x8-1.0	10.00±0.30	3.20±0.20	8.00±0.40	8.00±0.30	1.00±0.20	3
11	FS 13.84x3.94x1.88-1.52	13.84±0.15	3.94±0.15	1.88±0.15	9.78±0.15	1.52±0.15	5
12	FS 14.7x2.75x6-0.7	14.70±0.40	2.75±0.30	6.00±0.30	11.00±0.40	0.70±0.30	2
13	FS 14.7x2.75x12-0.7	14.70±0.40	2.75±0.30	12.00±0.40	11.00±0.40	0.70±0.30	2

※Other sizes are available upon request.

※All the data listed in this catalogue are for reference only, King Core reserves the right to alter or revise the specifications without prior notification.



KING CORE ELECTRONICS INC.
 Tel:886-3-4698855 Fax:886-3-4691395

No.269,Nanfong Rd.,Pingjhen City,Taoyuan County,Taiwan
 E-mail:kc@mail.kingcore.com.tw Web Site:http://www.kingcore.com.tw

SPECIFICATION OF FS SERIES

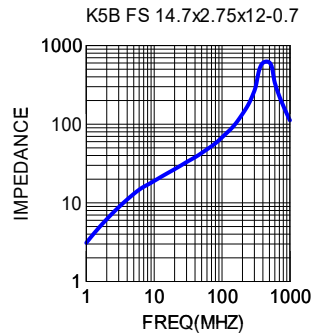
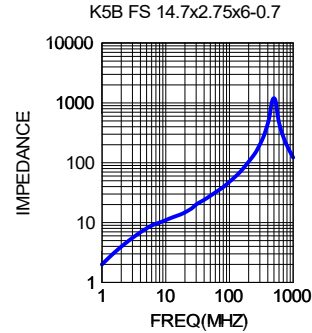
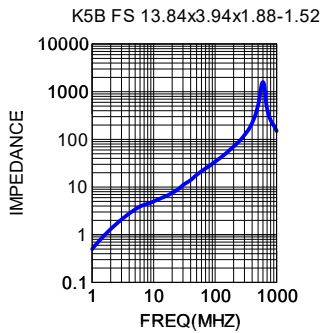
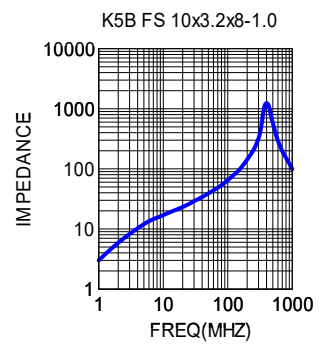
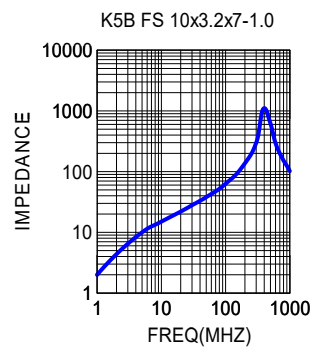
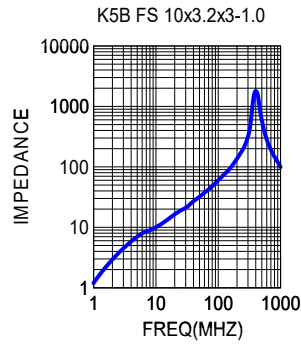
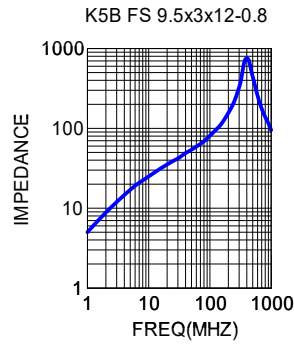
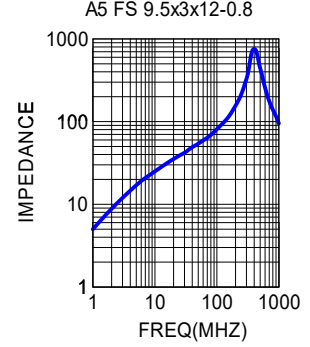
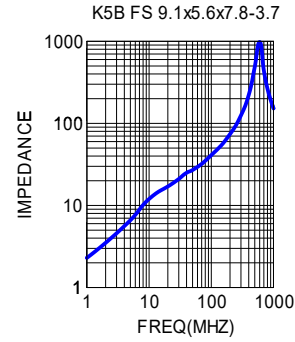
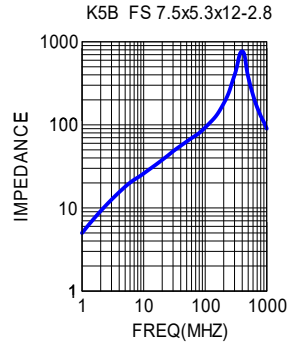
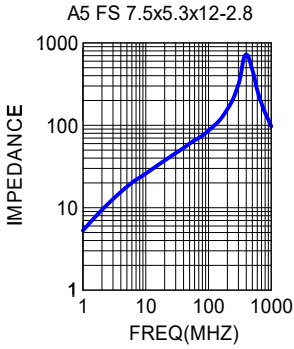
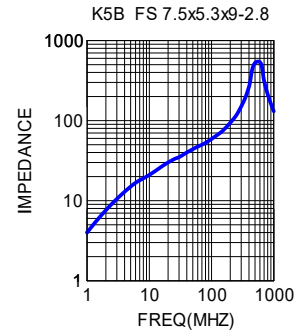
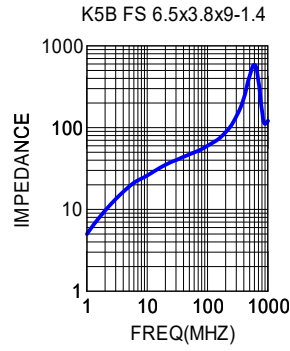
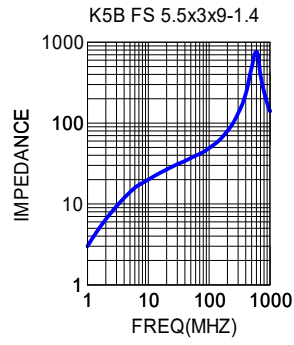
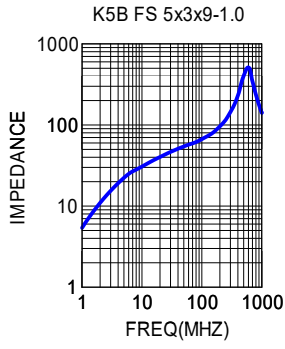

※Other sizes are available upon request.

※All the data listed in this catalogue are for reference only, King Core reserves the right to alter or revise the specifications without prior notification.



KING CORE ELECTRONICS INC.
Tel:886-3-4698855 Fax:886-3-4691395

No.269,Nanfong Rd.,Pingjhen City,Taoyuan County,Taiwan
E-mail:kc@mail.kingcore.com.tw Web Site:http://www.kingcore.com.tw

SPECIFICATION OF FS SERIES

NO.	ORDERING CODE	A	B	C	D	E	Fig
14	FS 16x3x5-0.8	16.00±0.40	3.00±0.20	5.00±0.30	11.50±0.40	0.50(+0.60/-0.00)	2
15	FS 16x3x8-0.8	16.00±0.40	3.00±0.20	8.00±0.40	11.50±0.40	0.50(+0.60/-0.00)	2
16	FS 16x4x4-0.8	16.00±0.40	4.00±0.20	4.00±0.30	11.50±0.40	0.50(+0.60/-0.00)	2
17	FS 16x5x3-0.8	16.00±0.60	5.00(+0.00/-0.70)	3.00±0.30	11.50±0.50	0.50(+0.60/-0.00)	2
18	FS 16x5x6-0.8	16.00±0.40	5.00(+0.00/-0.70)	6.00±0.50	11.50±0.40	0.50(+0.60/-0.00)	2
19	FS 16x5x8-0.8	16.00±0.40	5.00(+0.00/-0.70)	8.00±0.40	11.50±0.40	0.50(+0.60/-0.00)	2
20	FS 16x5x12-0.8	16.00±0.40	5.00(+0.00/-0.70)	12.00±0.50	11.50±0.40	0.50(+0.60/-0.00)	2
21	FS 16x5x12-1.2	16.00±0.40	5.00(+0.00/-0.70)	12.00±0.50	11.50±0.40	1.20±0.30	2
22	FS 16x5x15-0.8	16.00±0.40	5.00(+0.00/-0.70)	15.00±0.50	11.50±0.40	0.50(+0.60/-0.00)	2
23	FS 16x5x20-0.8	16.00±0.40	5.00(+0.00/-0.70)	20.00±0.50	11.50±0.40	0.50(+0.60/-0.00)	2
24	FS 18x5x8-1.0	18.00±1.00	5.00±0.30	8.00±0.50	14.00±0.50	1.00±0.50	2
25	FS 18x5x12-1.0	18.00±1.00	5.00±0.30	12.00±0.50	14.00±0.50	1.00±0.50	2
26	FS 18.3x12x30-5.25	18.30±0.40	12.00±0.40	30.00±0.50	11.50±0.40	5.25±0.25	2
27	FS 18.9x6.5x20-1.8	18.90±0.50	6.50±0.40	20.00±0.50	14.00±0.60	1.80±0.30	2
28	FS 19x3x8-0.8	19.00±0.40	3.00±0.20	8.00±0.40	14.50±0.40	0.50(+0.60/-0.00)	2
29	FS 19x6.5x12-1.8	19.00±0.70	6.50±0.50	12.00±0.50	14.00±0.40	1.80±0.20	2
30	FS 20.5x3.5x15-0.8	20.50±0.60	3.50±0.15	15.00±0.40	16.50±0.40	0.80±0.15	2
31	FS 23.3x2.5x7-0.9	23.30±0.70	2.50±0.20	7.00±0.30	20.00±0.50	0.90±0.20	1
32	FS 23.3x3x6-0.9	23.30±0.70	3.00±0.40	6.00±0.50	20.00±0.50	0.90±0.20	1
33	FS 23.3x3x7-0.9	23.30±0.70	3.00(+0.40/-0.20)	7.00±0.30	20.00±0.50	0.90±0.20	1
34	FS 23.3x3x10-0.9	23.30±0.70	3.00(+0.40/-0.20)	10.00±0.40	20.00±0.50	0.90±0.20	1
35	FS 23.3x3x12-0.9	23.30±0.70	3.00(+0.40/-0.20)	12.00±0.50	20.00±0.50	0.90±0.20	1
36	FS 23.3x3x15-0.9	23.30±0.70	3.00(+0.40/-0.20)	15.00±0.60	20.00±0.50	0.90±0.20	1
37	FS 23.8x3.2x15-1.1	23.80±0.80	3.20±0.20	15.00±0.60	18.70±0.80	1.10±0.40	1
38	FS 23.8x6.3x7-1.1	23.80±0.80	6.30±0.40	7.00±0.30	18.70±0.80	1.10±0.40	2
39	FS 23.8x6.3x12.5-1.1	23.80±0.80	6.30±0.40	12.50±0.40	18.70±0.80	1.10±0.40	2
40	FS 24x12x30-4.0	24.00±0.70	12.00±0.40	30.00±0.70	15.00±0.50	4.00±0.40	2
41	FS 24.5x5x12-0.5	24.50±0.70	5.00(+0.00/-0.70)	12.00±0.40	20.00±0.50	0.50(+0.60/-0.00)	2
42	FS 24.5x5x20-0.5	24.50±0.50	5.00(+0.00/-0.70)	20.00±0.60	20.00±0.50	0.50(+0.60/-0.00)	2
43	FS 25x3.7x20-0.7	25.00±0.70	3.70±0.40	20.00±0.60	22.00±0.50	0.70(+0.50/-0.10)	2
44	FS 25.5x3x9-0.65	25.50±0.70	3.00±0.20	9.00±0.40	21.50±0.50	0.65±0.30	2
45	FS 25.5x3x12-0.65	25.50±0.70	3.00±0.20	12.00±0.50	21.50±0.50	0.65±0.30	2
46	FS 25.5x3x9-0.65	25.50±0.70	3.00±0.20	9.00±0.40	21.50±0.50	0.65±0.30	2
47	FS 25.5x5x15-0.65	25.50±0.70	5.00±0.30	15.00±0.60	21.50±0.50	0.65±0.30	1

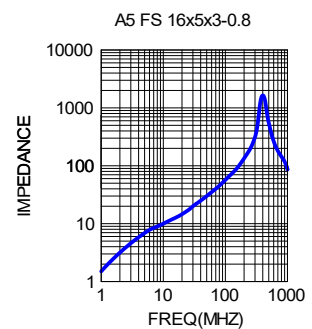
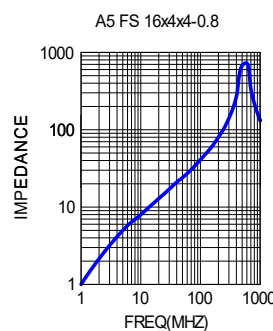
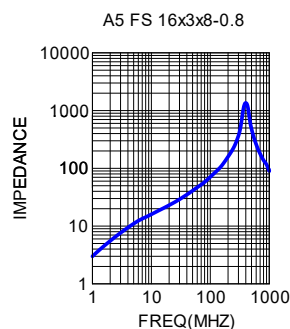
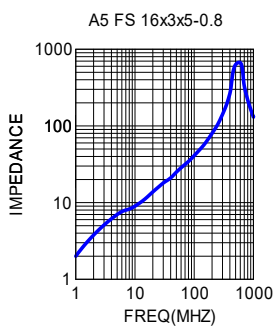

※Other sizes are available upon request.

※All the data listed in this catalogue are for reference only, King Core reserves the right to alter or revise the specifications without prior notification.



KING CORE ELECTRONICS INC.
Tel:886-3-4698855 Fax:886-3-4691395

No.269,Nanfong Rd.,Pingjhen City,Taoyuan County,Taiwan
E-mail:kc@mail.kingcore.com.tw Web Site:http://www.kingcore.com.tw

SPECIFICATION OF FS SERIES

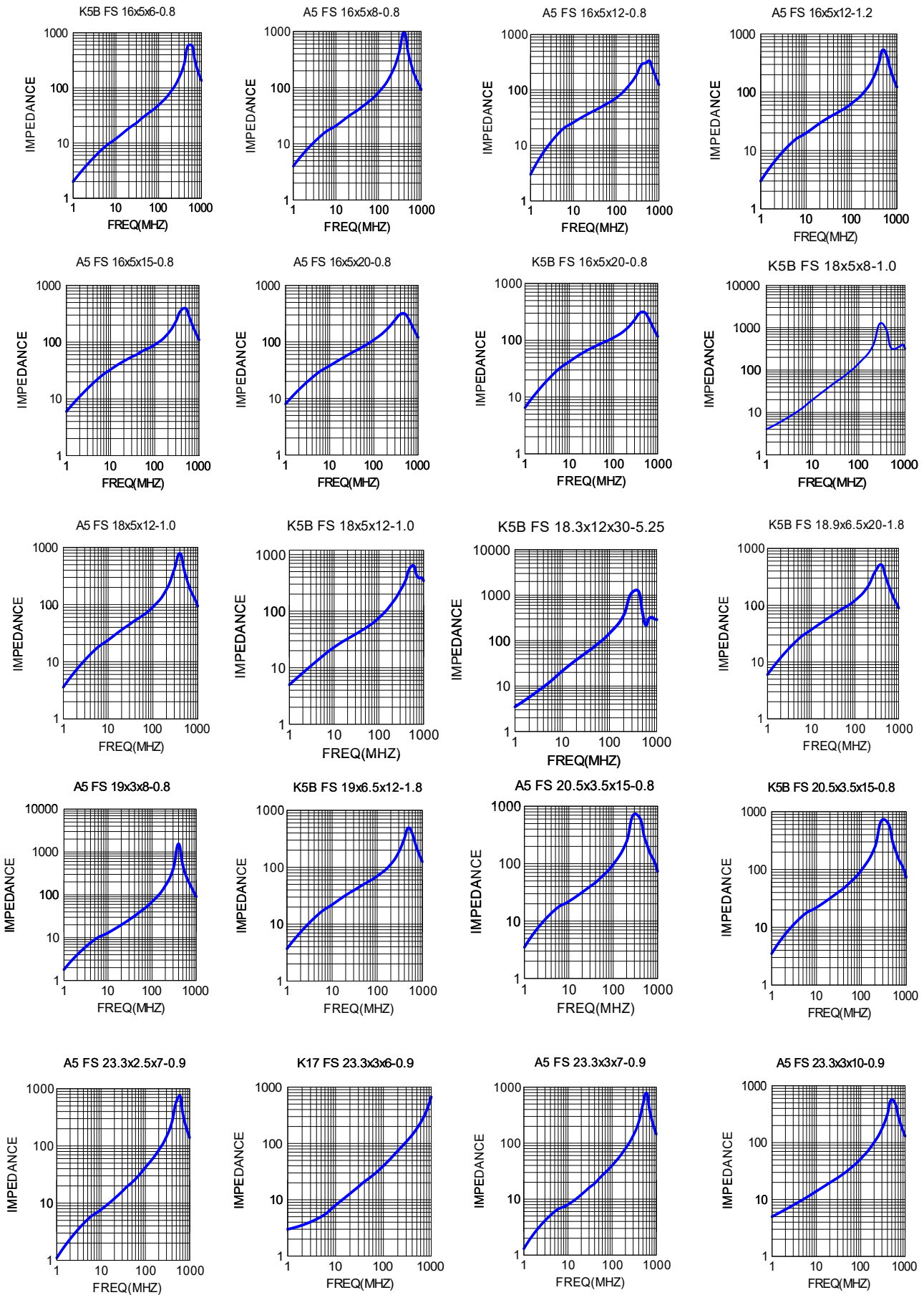

※Other sizes are available upon request.

※All the data listed in this catalogue are for reference only, King Core reserves the right to alter or revise the specifications without prior notification.



KING CORE ELECTRONICS INC.
 Tel: 886-3-4698855 Fax: 886-3-4691395

No.269, Nanfong Rd., Pingjhen City, Taoyuan County, Taiwan
 E-mail: kc@mail.kingcore.com.tw Web Site: http://www.kingcore.com.tw

SPECIFICATION OF FS SERIES

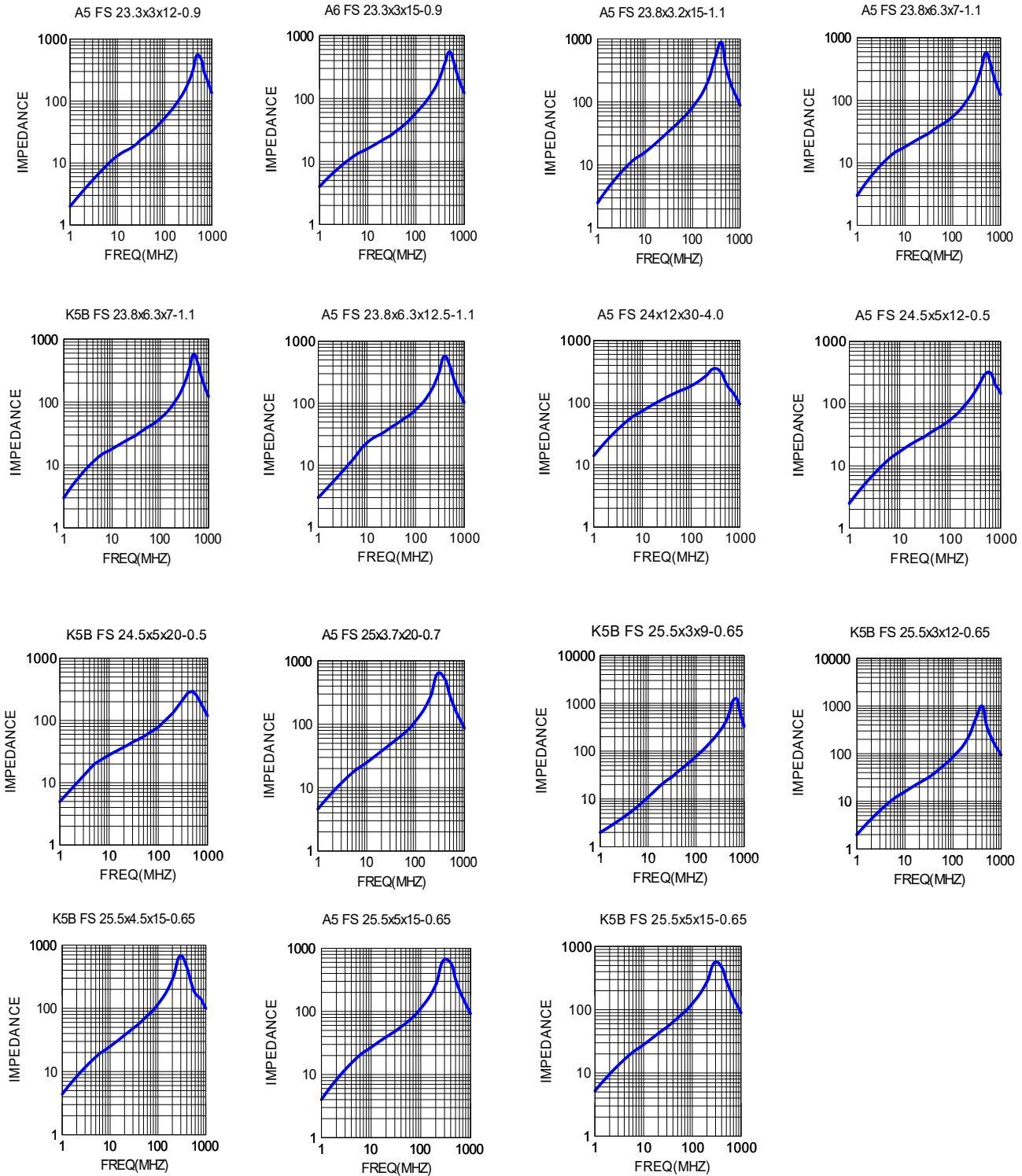

※Other sizes are available upon request.

※All the data listed in this catalogue are for reference only, King Core reserves the right to alter or revise the specifications without prior notification.



KING CORE ELECTRONICS INC.
 Tel:886-3-4698855 Fax:886-3-4691395

No.269,Nanfong Rd.,Pingjhen City,Taoyuan County,Taiwan
 E-mail:kc@mail.kingcore.com.tw Web Site:http://www.kingcore.com.tw

SPECIFICATION OF FS SERIES

NO.	ORDERING CODE	A	B	C	D	E	Fig
48	FS 28.5x6.5x8-0.8	28.50±1.00	6.50±0.50	8.00±0.40	23.50±0.50	0.80±0.30	2
49	FS 28.5x6.5x15-1.0	28.50±1.00	6.50±0.50	15.00±0.60	23.50±0.70	1.00±0.20	2
50	FS 28.5x6.5x18-1.0	28.50±1.00	6.50±0.50	18.00±0.70	23.50±0.70	1.00±0.20	2
51	FS 28.6x7.7x10-1.7	28.60±0.50	7.70±0.50	10.00±0.40	23.50±0.50	1.70±0.50	2
52	FS 28.6x7.7x14.6-1.7	28.60±0.50	7.70±0.50	14.60±0.60	23.50±0.50	1.70±0.50	2
53	FS 31x3x8-1.0	31.00±1.00	3.00±0.20	8.00±0.40	27.00±0.70	1.00±0.20	2
54	FS 31x3x12-1.0	31.00±1.00	3.00±0.20	12.00±0.50	27.00±0.70	1.00±0.20	2
55	FS 31x4x20-0.7	31.00±1.00	4.00±0.30	20.00±0.60	27.00±0.70	0.70±0.20	2
56	FS 31x5x9-1.0	31.00±1.00	5.00±0.30	9.00±0.40	27.00±0.70	1.00±0.20	2
57	FS 31x5x12-1.0	31.00±1.00	5.00±0.30	12.00±0.50	27.00±0.70	1.00±0.20	2
58	FS 31x5x18-1.0	31.00±1.00	5.00±0.30	18.00±0.60	27.00±0.70	1.00±0.20	2
59	FS 32x4x25-0.7	32.00±1.00	4.00±0.20	25.00±0.50	27.00(+2.00/-0.00)	0.70(+0.30/-0.00)	2
60	FS 32x6x25-0.85	32.00±1.00	6.00±0.30	25.00±1.00	28.00±0.70	0.85±0.20	2
61	F3S 32x11.8x16-1.0	32.00±0.80	11.80±0.50	16.00±0.60	27.00±0.90	1.00±0.30	4
62	FS 33.5x6.5x8-1.3	33.50±1.00	6.50±0.50	8.00±0.30	27.00±0.70	1.30(+0.50/-0.30)	2
63	FS 33.5x6.5x10-1.3	33.50±1.00	6.50±0.50	10.00±0.40	27.00±0.70	1.30(+0.50/-0.30)	2
64	FS 33.5x6.5x12-1.3	33.50±1.00	6.50±0.50	12.00±0.50	27.00±0.70	1.30(+0.50/-0.30)	2
65	FS 33.5x6.5x15-1.3	33.50±1.00	6.50±0.50	15.00±0.50	27.00±0.70	1.30(+0.50/-0.30)	2
66	FS 33.5x6.5x20-1.3	33.50±1.00	6.50±0.50	20.00±0.60	27.00±0.70	1.30(+0.50/-0.30)	2

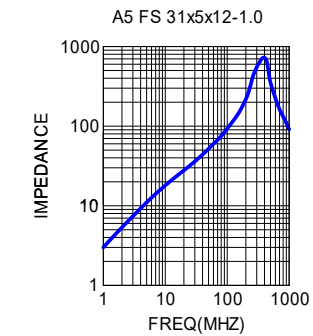
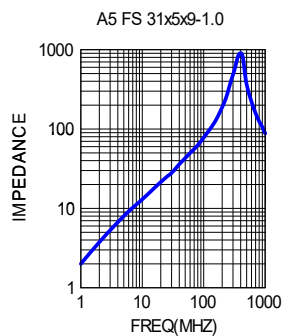
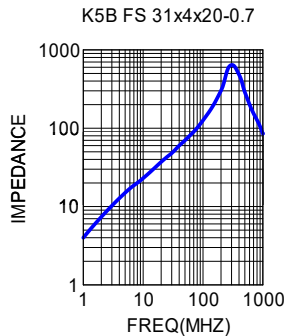
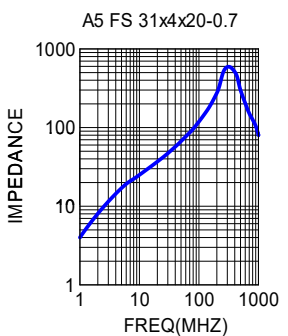
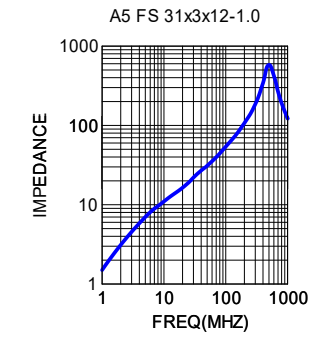
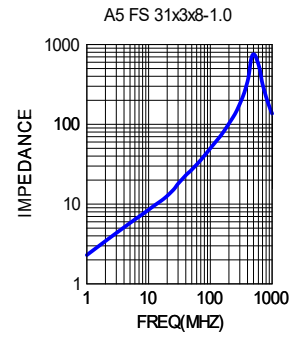
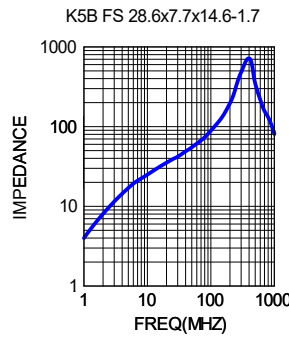
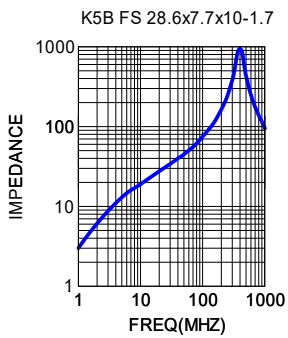
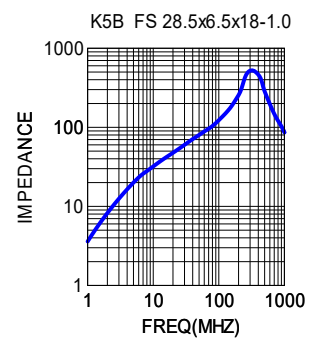
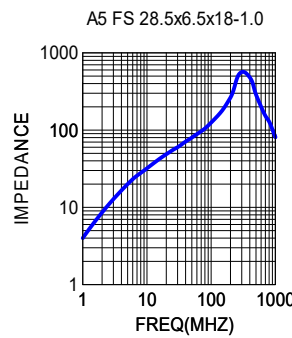
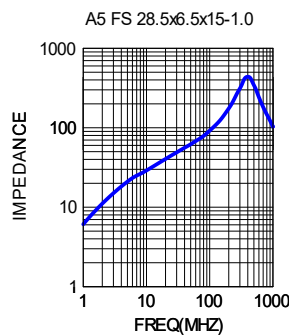
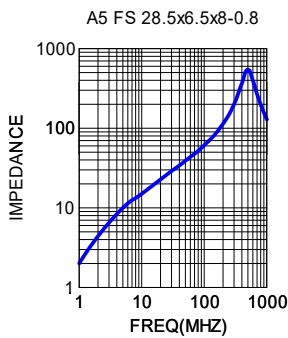

※Other sizes are available upon request.

※All the data listed in this catalogue are for reference only, King Core reserves the right to alter or revise the specifications without prior notification.



KING CORE ELECTRONICS INC.
Tel:886-3-4698855 Fax:886-3-4691395

No.269,Nanfong Rd.,Pingjhen City,Taoyuan County,Taiwan
E-mail:kc@mail.kingcore.com.tw Web Site:http://www.kingcore.com.tw

SPECIFICATION OF FS SERIES

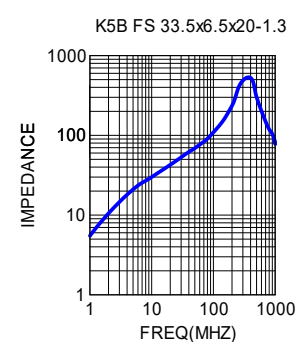
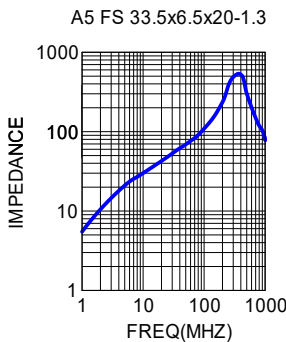
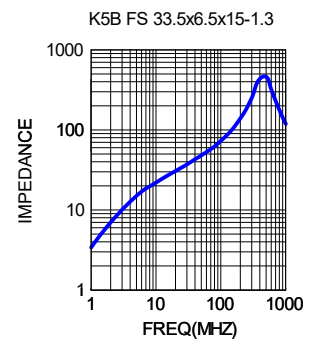
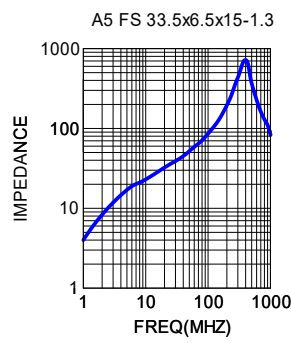
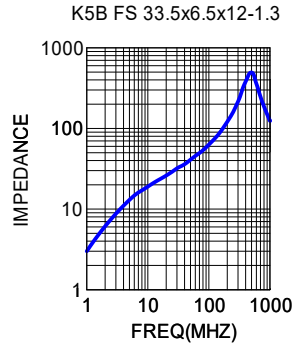
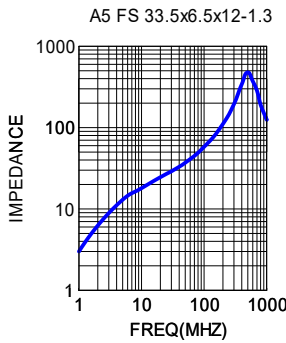
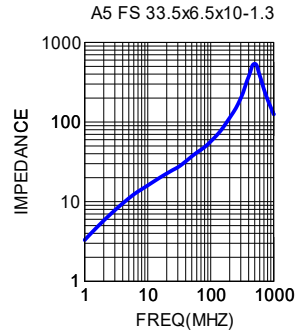
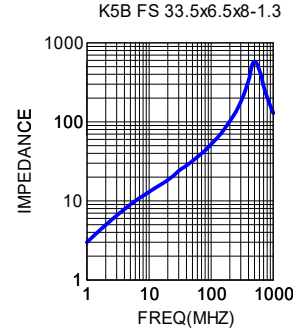
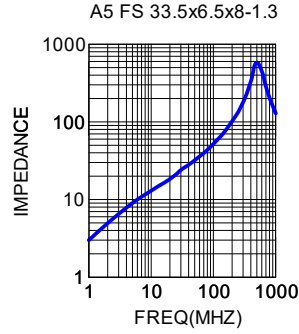
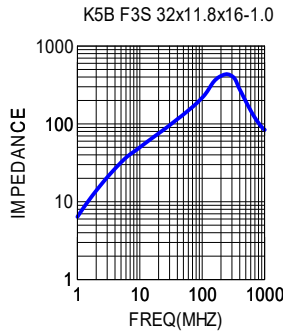
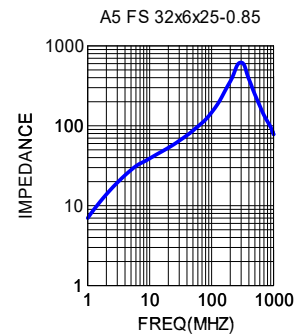
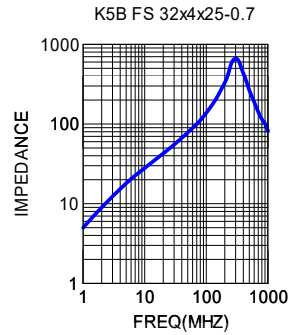
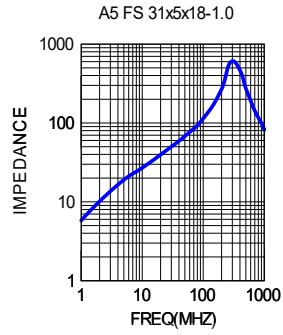
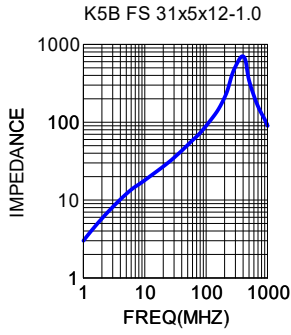

※Other sizes are available upon request.

※All the data listed in this catalogue are for reference only, King Core reserves the right to alter or revise the specifications without prior notification.



KING CORE ELECTRONICS INC.
Tel:886-3-4698855 Fax:886-3-4691395

No.269,Nanfong Rd.,Pingjhen City,Taoyuan County,Taiwan
E-mail:kc@mail.kingcore.com.tw Web Site:http://www.kingcore.com.tw

SPECIFICATION OF FS SERIES

NO.	ORDERING CODE	A	B	C	D	E	Fig
67	FS 36x6.5x18-0.6	36.00±1.00	6.50±0.50	18.00±0.60	31.00±0.70	0.60±0.30	2
68	FS 36x7.5x8-1.0	36.00±1.00	7.50±0.50	8.00±0.40	31.00±0.70	1.00±0.20	2
69	FS 36x7.5x20-1.0	36.00±1.00	7.50±0.50	20.00±1.00	31.00±0.70	1.00±0.20	2
70	FS 36x7.5x30-1.0	36.00±1.00	7.50±0.50	30.00±0.80	31.00±0.70	1.00±0.20	2
71	FS 36x7.5x36-1.0	36.00±1.00	7.50±0.50	36.00±1.00	31.00±0.70	1.00±0.20	2
72	FS 36.6x5x12-0.8	36.00±1.00	5.00±0.20	12.00±0.50	32.40±0.70	0.80±0.30	2
73	FS 38.5x4x12-0.8	38.50±1.00	4.00±0.30	12.00±0.50	35.00±0.70	0.80±0.30	2
74	FS 38.5x4x15-0.8	38.50±1.00	4.00±0.50	15.00±0.60	35.00±0.70	0.80±0.30	2
75	FS 38.53x12.06x25.4-1.9	38.53±0.58	12.06±0.38	25.40±0.76	26.77±0.76	1.90±0.38	1
76	FS 40x6.5x6-1.3	40.00±1.00	6.50±0.50	6.00±0.30	35.00±0.70	1.30(+0.50/-0.30)	2
77	FS 40x6.5x8-1.3	40.00±1.00	6.50±0.50	8.00±0.40	35.00±0.70	1.30(+0.50/-0.30)	2
78	FS 40x6.5x10-1.3	40.00±1.00	6.50±0.50	10.00±0.40	35.00±0.70	1.30(+0.50/-0.30)	2
79	FS 40x6.5x12-1.3	40.00±1.00	6.50±0.50	12.00±0.50	35.00±0.70	1.30(+0.50/-0.30)	2
80	FS 40x6.5x12-2.0	40.00±1.00	6.50±0.50	12.00±0.50	35.00±0.70	2.00±0.30	2
81	FS 40x6.5x15-1.3	40.00±1.00	6.50±0.50	15.00±0.60	35.00±0.70	1.30(+0.50/-0.30)	2
82	FS 40x6.5x18-1.3	40.00±1.00	6.50±0.50	18.00±0.70	35.00±0.70	1.30(+0.50/-0.30)	2
83	FS 40x6.5x20-1.3	40.00±1.00	6.50±0.50	20.00±0.60	35.00±0.70	1.30(+0.50/-0.30)	2
84	FS 40x11.4x5-7.4	40.00±1.00	11.40±0.50	5.00±0.40	32.00±0.80	7.40±0.50	3
85	FS 45.1x12.5x28.5-1.5	45.10±0.76	12.50±0.25	28.50±0.64	34.40±0.64	1.50±0.25	1
86	FS 45.2x6.5x12-1.3	45.20±1.00	6.50±0.50	12.00±0.50	40.00±0.80	1.30(+0.50/-0.30)	2
87	FS 45.2x6.5x15-1.3	45.20±1.00	6.50±0.50	15.00±0.60	40.00±0.80	1.30(+0.50/-0.30)	2

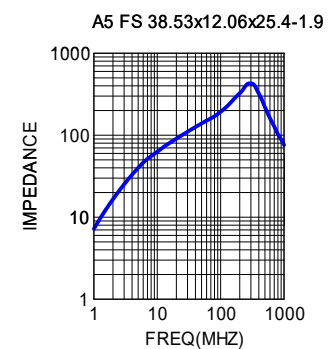
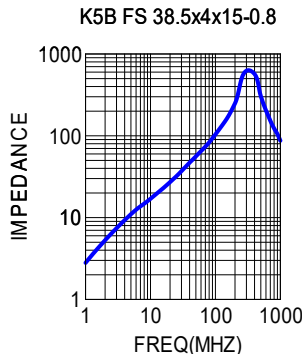
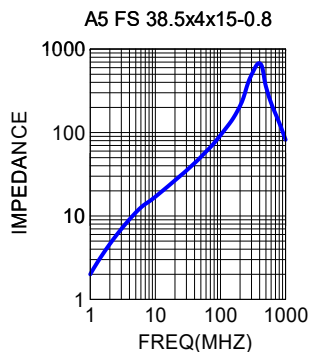
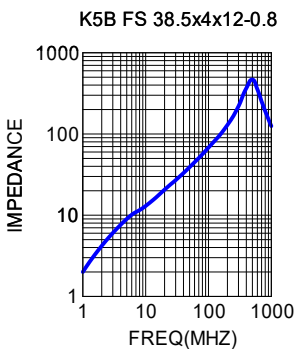
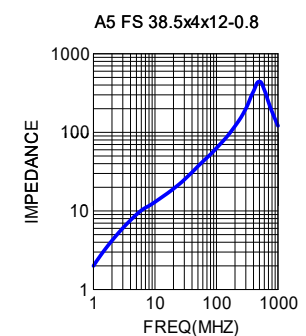
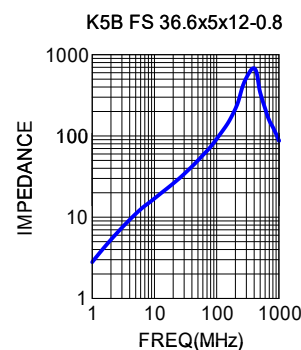
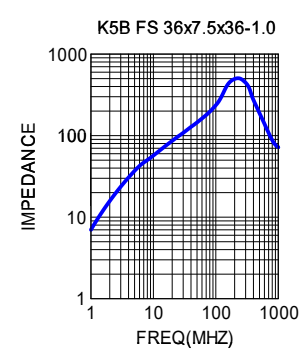
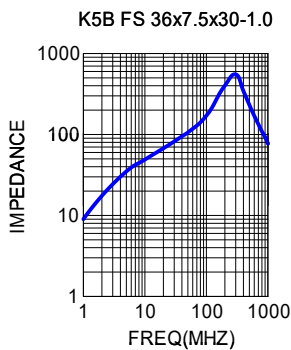
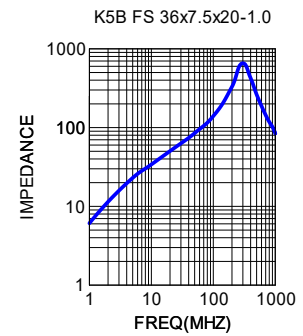
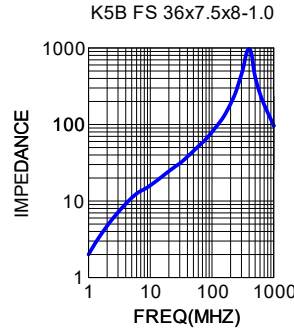
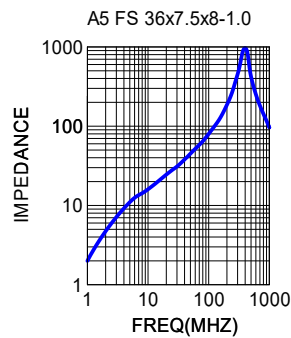
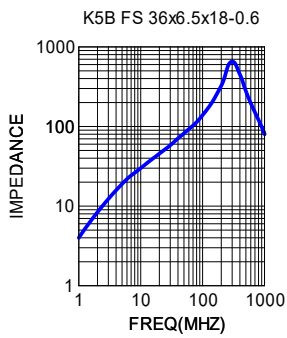

※Other sizes are available upon request.

※All the data listed in this catalogue are for reference only, King Core reserves the right to alter or revise the specifications without prior notification.



KING CORE ELECTRONICS INC.
Tel:886-3-4698855 Fax:886-3-4691395

No.269,Nanfong Rd.,Pingjhen City,Taoyuan County,Taiwan
E-mail:kc@mail.kingcore.com.tw Web Site:http://www.kingcore.com.tw

SPECIFICATION OF FS SERIES

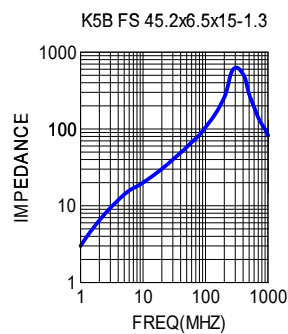
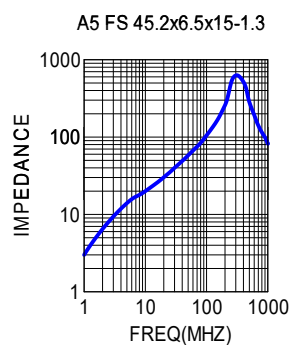
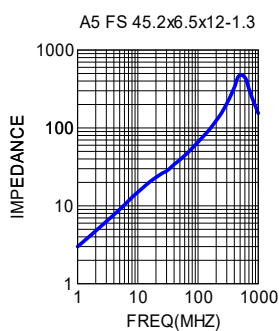
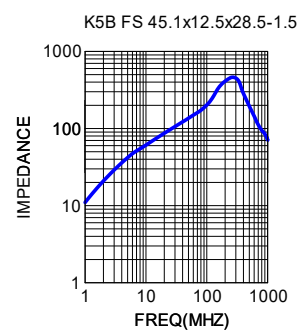
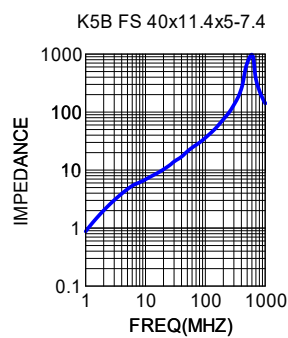
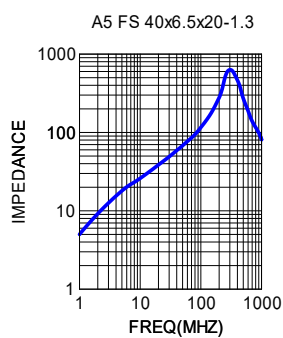
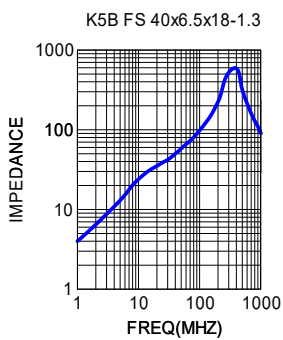
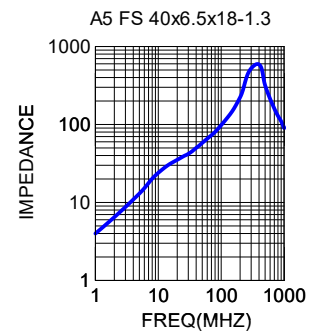
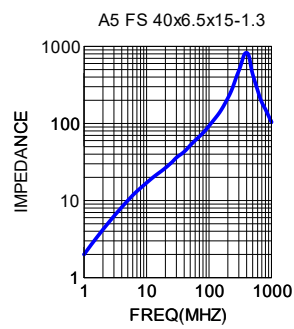
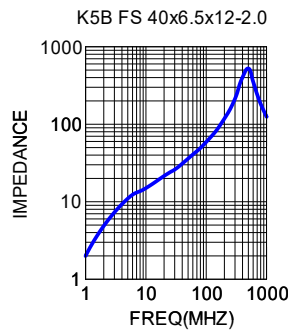
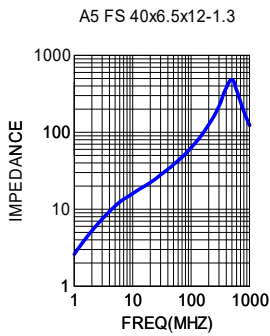
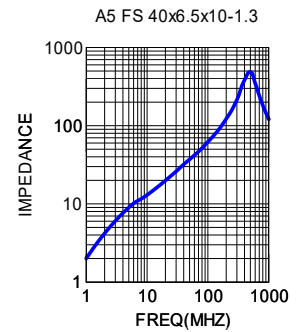
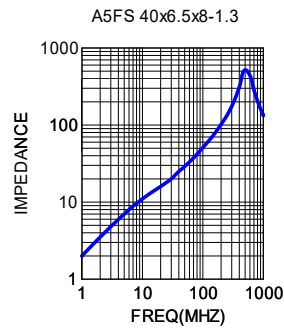
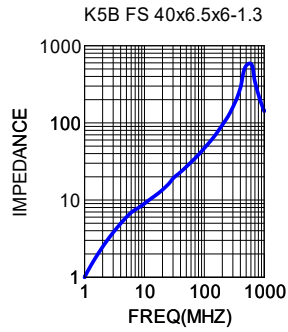
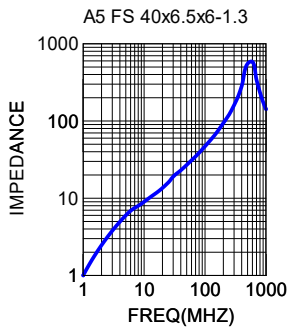

※Other sizes are available upon request.

※All the data listed in this catalogue are for reference only, King Core reserves the right to alter or revise the specifications without prior notification.



KING CORE ELECTRONICS INC.
Tel:886-3-4698855 Fax:886-3-4691395

No.269,Nanfong Rd.,Pingjhen City,Taoyuan County,Taiwan
E-mail:kc@mail.kingcore.com.tw Web Site:http://www.kingcore.com.tw

SPECIFICATION OF FS SERIES

NO.	ORDERING CODE	A	B	C	D	E	Fig
88	FS 49.6x6.5x8-1.3	49.60±1.00	6.50±0.50	8.00±0.40	44.00±0.80	1.30(+0.50/-0.30)	2
89	FS 49.6x6.5x10-1.3	49.60±1.00	6.50±0.50	10.00±0.40	44.00±0.80	1.30(+0.50/-0.30)	2
90	FS 49.6x6.5x12-1.3	49.60±1.00	6.50±0.50	12.00±0.50	44.00±0.80	1.30(+0.50/-0.30)	2
91	FS 49.6x6.5x15-1.3	49.60±1.00	6.50±0.50	15.00±0.50	44.00±0.80	1.30(+0.50/-0.30)	2
92	FS 49.6x7x12-1.8	49.60±1.00	7.00±0.50	12.00±0.50	44.00±0.80	1.80±0.40	2
93	FS 50x6.5x12-1.4	50.00±1.00	6.50±0.50	12.00±0.50	44.90±0.80	1.40±0.20	2
94	FS 57.6x6.5x12-1.3	57.60±1.20	6.50±0.50	12.00±0.50	52.00±0.90	1.30(+0.50/-0.30)	2
95	FS 58.6x7.5x20-1.3	58.60±1.20	7.50±0.50	20.00±0.60	52.00±0.90	1.30(+0.50/-0.30)	2
96	FS 60x12x12.7-2.2	60.00±1.00	12.00±0.50	12.70±0.60	48.50±0.80	2.20±0.40	1
97	FS 60.6x6.5x12-1.3	60.60±1.20	6.50±0.50	12.00±0.50	55.20(+1.00/-0.50)	1.30(+0.50/-0.30)	2

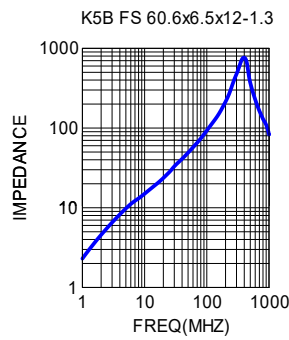
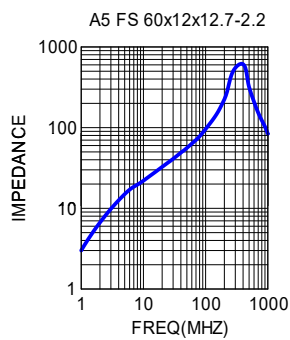
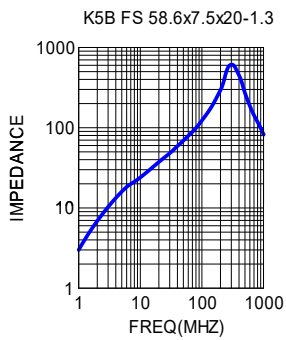
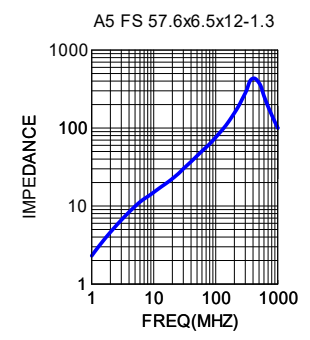
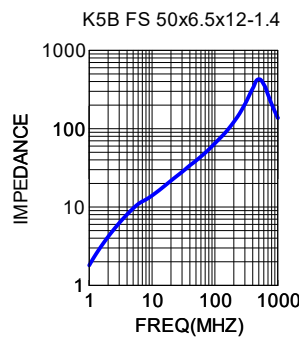
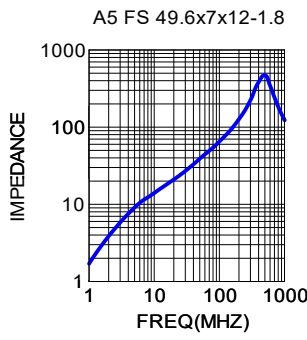
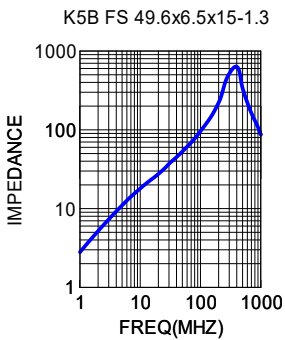
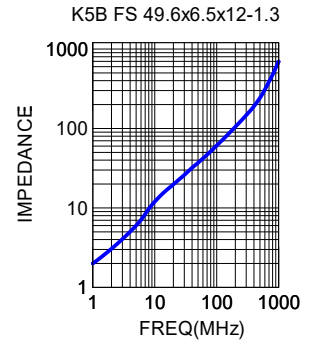
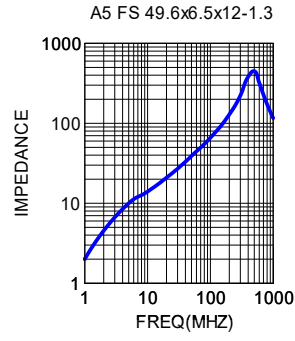
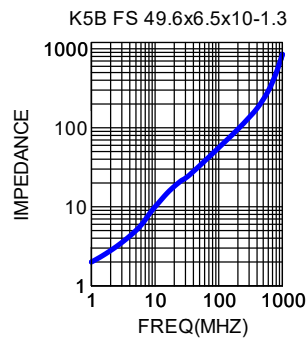
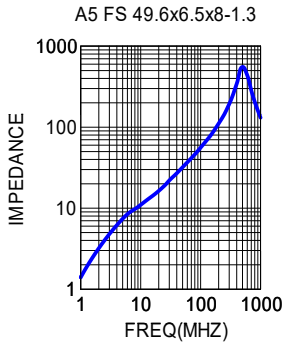

※Other sizes are available upon request.

※All the data listed in this catalogue are for reference only, King Core reserves the right to alter or revise the specifications without prior notification.



KING CORE ELECTRONICS INC.
Tel:886-3-4698855 Fax:886-3-4691395

No.269,Nanfong Rd.,Pingjhen City,Taoyuan County,Taiwan
E-mail:kc@mail.kingcore.com.tw Web Site:http://www.kingcore.com.tw