

SPECIFICATION OF BSF□□□NRSTY SERIES

FEATURES

1. Low profile and miniature size construction .
2. Magnetic shielded construction.
3. High saturation current.
4. For D/D converter units of new generation portable products.

APPLICATIONS

DVD、DSC、PDA、LCD display、
Smart phones、HDD、etc.

ORDERING CODE

BSF6028NRSTY 0R9 N T
(1)
(2)
(3)
(4)

- (1) Code of PRODUCT TYPE AND SIZE
 (2) INDUCTANCE
 (3) INDUCTANCE TOLERANCE (M : ±20%, N : ±30%)
 (4) REEL TAPING

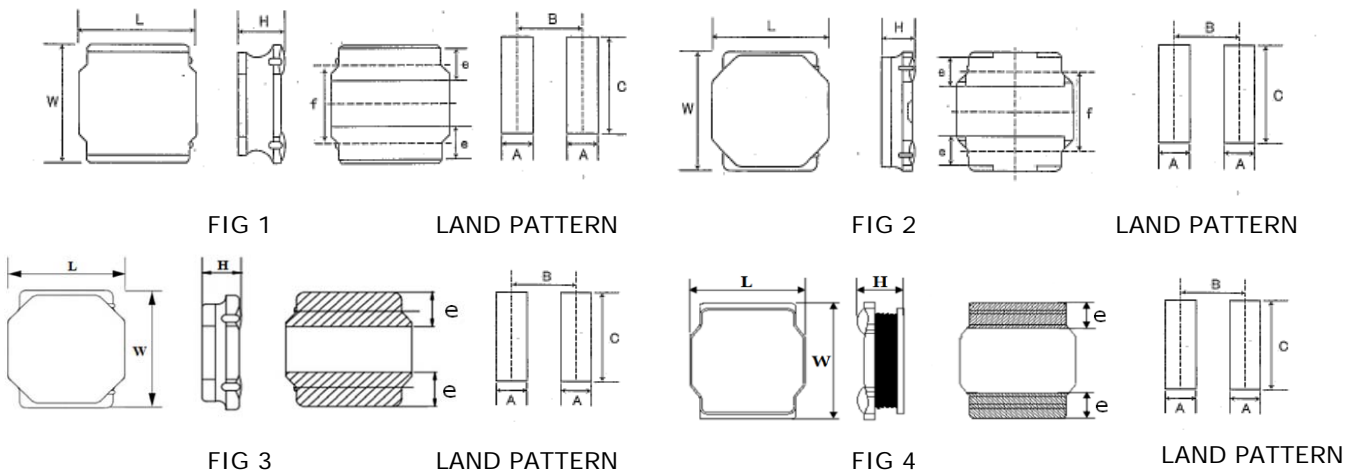
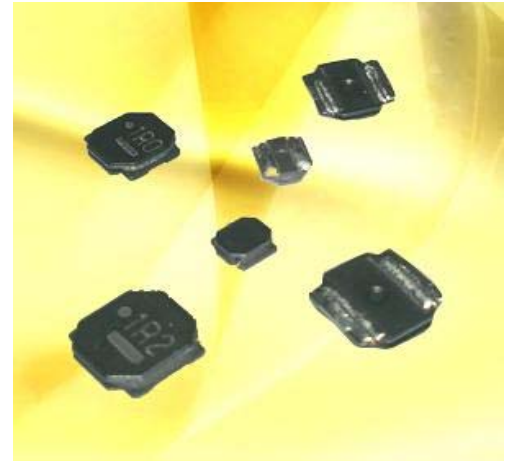

SHAPE & DIMENSIONS

SIZE CODE	L	W	H (max)	e	f	A	B	C	FIG
BSF3015NRSTY	3.0±0.1	3.0±0.1	1.5	0.9±0.2	1.9±0.2	0.8	2.2	2.7	1
BSF4010NRSTY	4.0±0.2	4.0±0.2	1.0	1.1±0.2	2.5±0.2	1.2	2.8	3.7	1
BSF4012NRSTY	4.0±0.2	4.0±0.2	1.2	1.1±0.2	2.5±0.2	1.2	2.8	3.7	1
BSF4018NRSTY	4.0±0.2	4.0±0.2	1.8	1.2REF	-	1.2	2.8	3.7	3
BSF5010NRSTY	4.9±0.2	4.9±0.2	1.0	1.2±0.2	3.3±0.2	1.5	3.6	4.0	2
BSF5012NRSTY	4.9±0.2	4.9±0.2	1.2	1.2±0.2	3.3±0.2	1.5	3.6	4.0	2
BSF5020NRSTY	4.9±0.3	4.9±0.3	2.2	1.3REF	-	1.5	3.6	4.0	3
BSF5024NRSTY	4.9±0.2	4.9±0.2	2.5	1.2±0.2	3.3±0.2	1.5	3.6	4.0	2
BSF5040NRSTY	4.9±0.3	4.9±0.3	4.1	1.3REF	-	1.5	3.6	4.0	3

※All the data listed in this catalogue are for reference only, King Core reserves the right to alter or revise the specifications without prior notification.

SPECIFICATION OF BSF□□□NRSTY SERIES

FEATURES

1. Low profile and miniature size construction .
2. Magnetic shielded construction.
3. High saturation current.
4. For D/D converter units of new generation portable products.

APPLICATIONS

DVD · DSC · PDA · LCD display ·
Smart phones · HDD · etc.

ORDERING CODE

BSF6028NRSTY 0R9 N T
(1) (2) (3) (4)

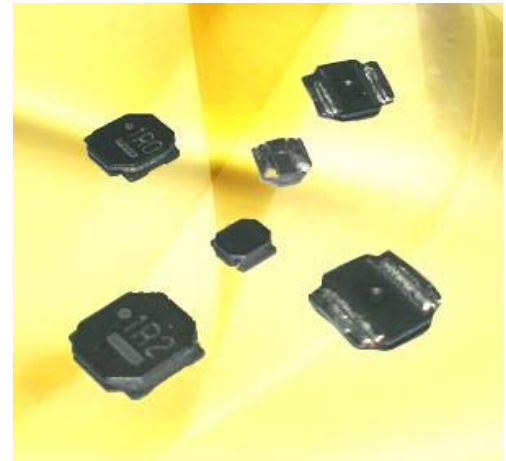

- (1) Code of PRODUCT TYPE AND SIZE
(2) INDUCTANCE
(3) INDUCTANCE TOLERANCE (M : ±20%, N : ±30%)
(4) REEL TAPING

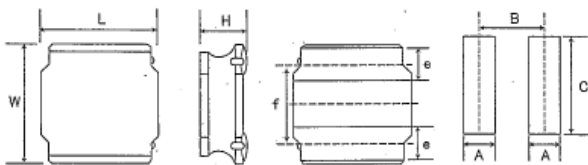

FIG 1

LAND PATTERN

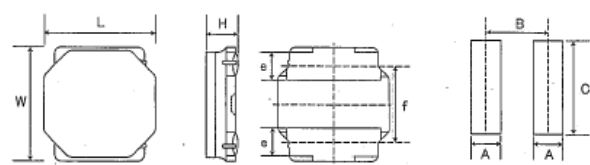

FIG 2

LAND PATTERN

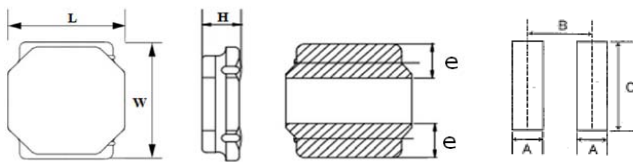

FIG 3

LAND PATTERN

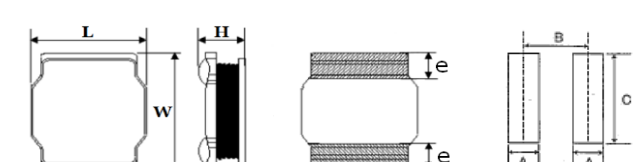

FIG 4

LAND PATTERN

SHAPE & DIMENSIONS

SIZE CODE	L	W	H (max)	e	f	A	B	C	FIG
BSF6010NRSTY	6.0±0.2	6.0±0.2	1.0	1.35±0.20	4.0±0.2	1.6	4.7	5.7	2
BSF6012NRSTY	6.0±0.2	6.0±0.2	1.2	1.35±0.20	4.0±0.2	1.6	4.7	5.7	2
BSF6014NRSTY	6.0±0.2	6.0±0.2	1.4	1.35±0.20	4.0±0.2	1.6	4.7	5.7	2
BSF6020NRSTY	6.0±0.2	6.0±0.2	2.0	1.35±0.20	4.0±0.2	1.6	4.7	5.7	2
BSF6028NRSTY	6.0±0.2	6.0±0.2	2.8	1.35±0.20	4.0±0.2	1.6	4.7	5.7	2
BSF6045NRSTY	6.0±0.2	6.0±0.2	4.5	1.6REF	-	1.6	4.7	5.7	3
BSF8030NRSTY	8.0±0.2	8.0±0.2	3.0	1.6±0.3	5.6±0.3	1.8	5.6	7.5	1
BSF8040NRSTY	8.0±0.2	8.0±0.2	4.2	2.1REF	-	1.8	5.6	7.5	4

※All the data listed in this catalogue are for reference only, King Core reserves the right to alter or revise the specifications without prior notification.

SMD POWER INDUCTORS → BSF6028NRSTY SERIES

ELECTRICAL CHARACTERISTIC

ORDERING CODE	Inductance (μH)	DC Resistance (Ω) $\pm 30\%$	Self Resonant Frequency (MHz)min	Isat (mA)max	IDC (mA)max
BSF6028NRSTY0R9NT	0.9	0.013	90	6700	4600
BSF6028NRSTY1R5NT	1.5	0.016	78	5100	4200
BSF6028NRSTY2R2NT	2.2	0.020	68	4200	3700
BSF6028NRSTY3R0NT	3.0	0.023	55	3600	3400
BSF6028NRSTY4R7MT	4.7	0.031	39	2700	3000
BSF6028NRSTY6R8MT	6.8	0.043	25	2600	2500
BSF6028NRSTY100MT	10	0.065	20	1900	1900
BSF6028NRSTY150MT	15	0.095	17	1600	1800
BSF6028NRSTY220MT	22	0.135	12	1300	1400
BSF6028NRSTY330MT	33	0.220	10	1100	1100
BSF6028NRSTY470MT	47	0.300	8	1000	920
BSF6028NRSTY680MT	68	0.420	5	800	770
BSF6028NRSTY101MT	100	0.600	3	650	660

※Test Frequency/Voltage: 100KHz/1V

※Tolerance: M $\pm 20\%$, N $\pm 30\%$

※Isat: Based on Inductance decrease 30%

※IDC: Based on Temperature increase 40°C

※Operating temperature range : -25 to +125°C (including self-generated heat)

※All the data listed in this catalogue are for reference only, King Core reserves the right to alter or revise the specifications without prior notification.